

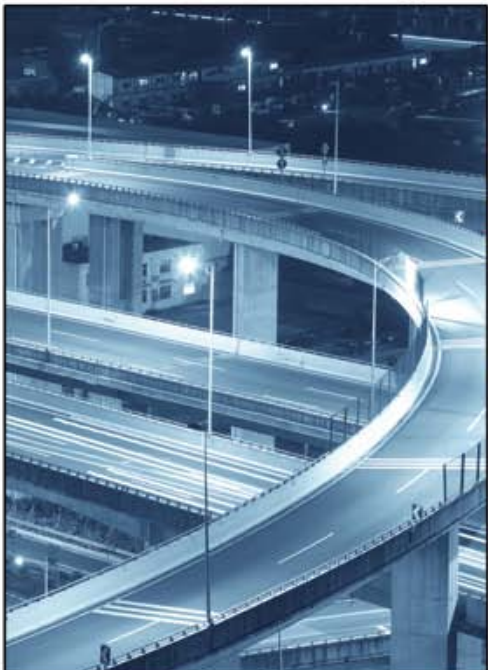

Innovative Vehicle Solutions  
[www.haldex.com](http://www.haldex.com)

# Camshaft/Bushing Kit Catalog L00122W - 6/14



## **Important Notice**

The products described within this literature, including without limitation, product features, specifications, designs, availability and pricing are subject to change by Haldex and its subsidiaries at any time without notice.

This document and other information from Haldex, its subsidiaries and authorized distributors provide product and/or system options for further investigation by users having technical expertise. It is important that you analyze all aspects of your application and review the information concerning the product or system, in the current literature or catalog. Due to the variety of operating conditions and applications for these products or systems, the user, through their own analysis and testing, is solely responsible for making the final selection of the products and systems and assuring that all performance, safety and warning requirements are met.

## 07 – Camshafts/Bushing Kits

<b>Table of Contents</b>	07-1
<b>Part Number Index</b>	07-3
<b>General Information</b>	
Foreword	07-4
<b>Drive Axle Camshafts</b>	
Eaton with 16-1/2" "ES" Extended Service & 15" "Reduced Envelope" Brakes	07-5
Eaton with 16-1/2" & 18" Single Anchor Pin Brakes	07-6
Meritor with 16-1/2" "P" Style Brakes	07-7
Meritor with 16-1/2" "Q" & "Q" Plus Brakes	07-8
<b>Steer Axle Camshafts</b>	
Eaton with 15" Extended Service "ES" Brakes	07-10
Meritor with 15" "Q" Brakes – 1-1/2" Offset Spider	07-11
Meritor with 15" x 4" "Q" Plus Brakes	07-12
<b>Trailer Axle Camshafts</b>	
Dana Spicer with 12-1/4" Fast-Rise Brakes – Pre-1996	07-13
Dana Spicer with 16-1/2" Brakes – Double Groove	07-14
Dana Spicer with 16-1/2" Brakes – Single Groove	07-15
Dana Spicer with 16-1/2" "Xtralife" Brakes – 1-5/8" Spider Bushing	07-16
Dana Spicer with 16-1/2" "Xtralife" Brakes – 10 Spline	07-17
Dana Spicer with 16-1/2" "Xtralife" Brakes – 28 Spline	07-18
Dana Spicer – Standard Forge – Dexter with 12-1/4" Brakes	07-19
Dexter with 12-1/4" Brakes	07-20
Eaton with 12-1/4" Brakes	07-21
Eaton with 16-1/2" "ES" Extended Service Brakes – 10 Spline	07-22
Eaton with 16-1/2" "ES" Extended Service Brakes – 28 Spline	07-23
Eaton "501" Series with 16-1/2" Brakes	07-24
Fruehauf "Propar" with 16-1/2" Brakes	07-25
Hendrickson Intraax® 16-1/2" Brakes	07-26
Hendrickson "XLS" 16-1/2" Brakes	07-27
Meritor with 16-1/2" "Q" Plus Brakes	07-28
Universal with 16-1/2" Brakes – Double Groove	07-29
Universal with 16-1/2" Brakes – Single Groove	07-30
<b>Bushing Kits</b>	
CQ62768-66740	07-31
CQ66918-66939	07-32
CQ66940-67111	07-33
CQ67128-67325	07-34
CQ67326-67329	07-35

## 07-CAMSHAFTS/BUSHING KITS

## Table of Contents

CQ67331-67335	07-36
CQ67353-67383	07-37
CQ67384-67387	07-38
CQ67410-67413	07-39
CQ67414-67443	07-40

# Part Number Index

# 07-CAMSHAFTS/BUSHING KITS

Part Number	Type	Page #	Part Number	Type	Page #	Part Number	Type	Page #	Part Number	Type	Page #
CQ62768	S	07-31	CS41113	S	07-28	CS41524	S	07-30			
CQ65501	S	07-31	CS41114	S	07-28	CS41525	S	07-30			
CQ65517	S	07-31	CS41115	S	07-28	CS41528	S	07-25			
CQ66740	S	07-31	CS41150	S	07-8	CS41529	S	07-25			
CQ66918	S	07-32	CS41151	S	07-8	CS41542	S	07-30			
CQ66920	S	07-32	CS41152	S	07-8	CS41543	S	07-30			
CQ66922	S	07-32	CS41153	S	07-8	CS41544	S	07-24			
CQ66939	S	07-32	CS41154	S	07-8	CS41545	S	07-24			
CQ66940	S	07-33	CS41155	S	07-8	CS41714	S	07-21			
CQ66941	S	07-33	CS41156	S	07-8	CS41715	S	07-21			
CQ67100	S	07-33	CS41157	S	07-8	CS41718	S	07-19			
CQ67111	S	07-33	CS41160	S	07-8	CS41719	S	07-19			
CQ67128	S	07-34	CS41161	S	07-8	CS41722	S	07-19			
CQ67138	S	07-34	CS41164	S	07-14	CS41723	S	07-19			
CQ67324	S	07-34	CS41165	S	07-14	CS41754	S	07-30			
CQ67325	S	07-34	CS41168	S	07-15	CS41755	S	07-30			
CQ67326	S	07-35	CS41169	S	07-15	CS41760	S	07-6			
CQ67327	S	07-35	CS41172	S	07-8	CS41761	S	07-6			
CQ67328	S	07-35	CS41173	S	07-8	CS41762	S	07-19			
CQ67329	S	07-35	CS41174	S	07-26	CS41763	S	07-19			
CQ67331	S	07-36	CS41175	S	07-26	CS41764	S	07-27			
CQ67332	S	07-36	CS41226	S	07-20	CS41765	S	07-27			
CQ67334	S	07-36	CS41227	S	07-20						
CQ67335	S	07-36	CS41266	S	07-30						
CQ67353	S	07-37	CS41267	S	07-30						
CQ67354	S	07-37	CS41284	S	07-30						
CQ67382	S	07-37	CS41285	S	07-30						
CQ67383	S	07-37	CS41292	S	07-24						
CQ67384	S	07-38	CS41293	S	07-24						
CQ67385	S	07-38	CS41328	S	07-17						
CQ67386	S	07-38	CS41329	S	07-17						
CQ67387	S	07-38	CS41362	S	07-13						
CQ67410	S	07-39	CS41363	S	07-13						
CQ67411	S	07-39	CS41390	S	07-17						
CQ67412	S	07-39	CS41391	S	07-17						
CQ67413	S	07-39	CS41398	S	07-18						
CQ67414	S	07-40	CS41399	S	07-18						
CQ67416	S	07-40	CS41400	S	07-18						
CQ67416W	S	07-40	CS41401	S	07-18						
CQ67417	S	07-40	CS41402	S	07-18						
CQ67417W	S	07-40	CS41403	S	07-18						
CQ67443	S	07-40	CS41404	S	07-18						
CS40116	S	07-11	CS41405	S	07-18						
CS40117	S	07-11	CS41408	S	07-18						
CS40134	S	07-12	CS41409	S	07-18						
CS40135	S	07-12	CS41414	S	07-16						
CS40172	S	07-8	CS41415	S	07-16						
CS40173	S	07-8	CS41416	S	07-16						
CS40174	S	07-8	CS41417	S	07-16						
CS40175	S	07-8	CS41420	S	07-16						
CS40178	S	07-8	CS41421	S	07-16						
CS40179	S	07-8	CS41422	S	07-16						
CS40182	S	07-8	CS41423	S	07-16						
CS40183	S	07-8	CS41432	S	07-16						
CS40184	S	07-8	CS41433	S	07-16						
CS40185	S	07-8	CS41434	S	07-16						
CS40186	S	07-8	CS41435	S	07-16						
CS40187	S	07-8	CS41441	S	07-10						
CS40188	S	07-8	CS41442	S	07-10						
CS40189	S	07-8	CS41446	S	07-6						
CS40192	S	07-8	CS41447	S	07-6						
CS40193	S	07-8	CS41458	S	07-5						
CS40196	S	07-8	CS41459	S	07-5						
CS40197	S	07-8	CS41460	S	07-5						
CS40198	S	07-8	CS41461	S	07-5						
CS40199	S	07-8	CS41476	S	07-22						
CS41014	S	07-7	CS41477	S	07-22						
CS41015	S	07-7	CS41480	S	07-23						
CS41016	S	07-7	CS41481	S	07-23						
CS41017	S	07-7	CS41482	S	07-23						
CS41028	S	07-7	CS41483	S	07-23						
CS41029	S	07-7	CS41492	S	07-25						
CS41036	S	07-7	CS41493	S	07-25						
CS41037	S	07-7	CS41506	S	07-29						
CS41042	S	07-6	CS41507	S	07-29						
CS41043	S	07-6	CS41512	S	07-25						
CS41052	S	07-14	CS41513	S	07-25						
CS41053	S	07-14	CS41514	S	07-30						
CS41110	S	07-28	CS41515	S	07-30						
CS41111	S	07-28	CS41522	S	07-29						
CS41112	S	07-28	CS41523	S	07-29						

Type "O" = OEM P/N, Type "S" = Service P/N

If OEM part # is not found on page listed, refer to the MCR for applicable cross reference.

## PURPOSE OF THIS SECTION

This section is designed as a reference for Haldex new and remanufactured air brake system components and accessories, sold under the Haldex and Midland product names. Products described include all pertinent information needed to replace an OEM installed component or to help design an original installation. If there is a service number for a given part, it is noted in the product number table.

## DESIGN FLEXIBILITY

The products presented in this section are described by function and usage. Technical data and mounting configurations are also provided. Throughout this section, reference is made to numerous specific OEM applications. This section is not, however, intended to be a mutually exclusive listing of all part numbers and designs available. Should the need for a design not presented occur, contact your Haldex sales representative for additional information.

## WARRANTY INFORMATION

Proper service and repair are important to the safe, reliable operation of any motor vehicle. To prevent personal injury and/or vehicle damage, careful and cautious service procedures recommended by the vehicle manufacturer should be followed by anyone servicing a motor vehicle. For details on warranty of Haldex air brake system components and accessories, refer to L20221 Aftermarket Warranty Policy. For warranty returns, use L90005 Warranty Adjustment Form. To obtain further information, visit the [www.haldex.com](http://www.haldex.com) website, select **North America/English** in drop down box then search for **Warranty**.

## ORDERING PROCEDURE

Most customers can place electronic orders on the [www.haldex.com](http://www.haldex.com) website by obtaining a username and password or by using EDI. For additional information about electronic orders or to place an order by phone or fax, contact Customer Service in U.S. or Canada at numbers listed below:

### U.S. Customer Service:

Phone: 800-643-2374  
 Fax: 800-533-1941  
 Mail: Haldex Brake Products Corporation  
 Attn: Customer Service Department  
 10930 N. Pomona Ave.  
 Kansas City, MO 64153

### Canada Customer Service:

Phone: 800-267-9247  
 Fax: 519-621-3924  
 Mail: Haldex Limited  
 Canadian Distribution Centre  
 Attn: Customer Service Department  
 500 Pinebush Road, Unit 1  
 Cambridge, Ontario N1T 0A5

## IMPORTANT NOTICE

The data listed herein is correct to the best of Haldex's knowledge and belief, having been compiled from reliable and official sources of information. However, HALDEX CANNOT ASSUME ANY RESPONSIBILITY for possible error or misapplication of the product. Final determination of the suitability of the products for the use contemplated by the Buyer is the sole responsibility of the Buyer. Haldex shall have no responsibility in connection with this suitability. It is not our intention to imply that any of the components in this catalog in connection with an engine make or model are made by any engine manufacturer.

Copyright 2014  
 Haldex Brake Products Corporation  
 10930 N. Pomona Ave.  
 Kansas City, MO 64153

All rights reserved.

Materials may only be reproduced with written permission of Haldex.

Eaton with 16-1/2" "ES" Extended Service & 15" "Reduced Envelope" Brakes

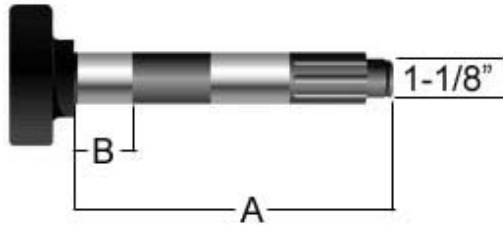
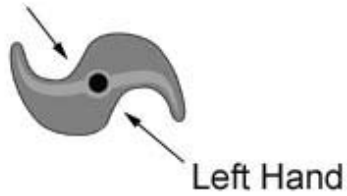

Left Hand Shown

Features:

- 1-1/2" Diameter – 10 Spline

Specifications:

Nominal Head Dimension 1-1/8"  
 Bushing Kit CQ65501

Notes:

- 1) MUST REPLACE RIGHT & LEFT HAND S-CAMS WHEN "ES" CAMS ARE USED TO REPLACE EARLY DESIGN S-CAMS.

SKU#	Product Description	Replaces	A	B	Notes
CS41458	Eaton with 16-1/2" "ES" Extended Service & 15" "Reduced Envelope" Brakes	Eaton 806526	11-1/2"	1-3/4"	Left Hand
CS41459	Eaton with 16-1/2" "ES" Extended Service & 15" "Reduced Envelope" Brakes	Eaton 806527	11-1/2"	1-3/4"	Right Hand
CS41460	Eaton with 16-1/2" "ES" Extended Service & 15" "Reduced Envelope" Brakes	Eaton 808290	12-1/2"	1-3/4"	Left Hand
CS41461	Eaton with 16-1/2" "ES" Extended Service & 15" "Reduced Envelope" Brakes	Eaton 808291	12-1/2"	1-3/4"	Right Hand

Eaton with 16-1/2" & 18" Single Anchor Pin Brakes

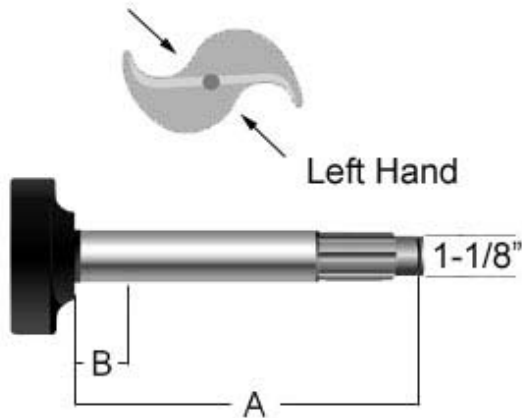

Features:

- 1-1/2" Diameter - 10 Spline

Specifications:

Nominal Head Dimension 1-3/8"  
 Bushing Kit CQ67326

Typical - Left Hand Shown

SKU#	Product Description	Replaces	A	B	Notes
CS41042	Eaton with 16-1/2" & 18" Single Anchor Pin Brakes	Eaton 71306	12-7/16"	1-21/32"	Left Hand
CS41043	Eaton with 16-1/2" & 18" Single Anchor Pin Brakes	Eaton 71307	12-7/16"	1-21/32"	Right Hand
CS41446	Eaton with 16-1/2" & 18" Single Anchor Pin Brakes	Eaton 76293, 45530	11-1/8"	1-21/32"	Left Hand
CS41447	Eaton with 16-1/2" & 18" Single Anchor Pin Brakes	Eaton 76294, 45531	11-1/8"	1-21/32"	Right Hand
CS41760	Eaton with 16-1/2" & 18" Single Anchor Pin Brakes	Eaton 70306 Navistar 385957C1	11-1/2"	1-21/32"	Left Hand
CS41761	Eaton with 16-1/2" & 18" Single Anchor Pin Brakes	Eaton 70307 Navistar 385958C1	11-1/2"	1-21/32"	Right Hand



Meritor with 16-1/2" "P" Style Brakes

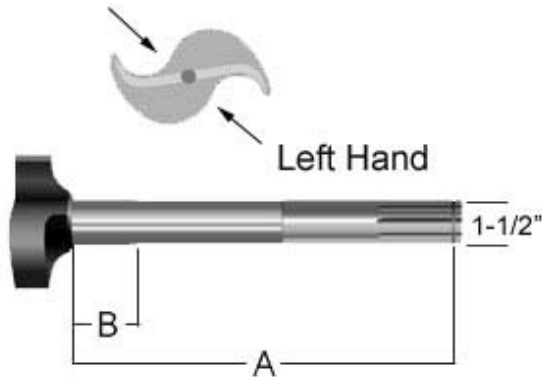

Features:

- 1-1/2 Diameter - 10 Spline

Specifications:

Nominal Head Dimension 1-3/8"  
 Bushing Kit CQ67327

Typical - Left Hand Shown

SKU#	Product Description	Replaces	A	B	Notes
CS41014	Meritor with 16-1/2" "P" Style Brakes	Meritor 2210-L-3028 and 2210-X-5354	11-9/32"	1-3/4"	Left Hand
CS41015	Meritor with 16-1/2" "P" Style Brakes	Meritor 2210-K-3027 and 2210-W-5353	11-9/32"	1-3/4"	Right Hand
CS41016	Meritor with 16-1/2" "P" Style Brakes	Meritor 2210-D-5360 and 2210-P-2980	11-1/2"	1-3/4"	Left Hand
CS41017	Meritor with 16-1/2" "P" Style Brakes	Meritor 2210-C-5359 and 2210-Q-2981	11-1/2"	1-3/4"	Right Hand
CS41028	Meritor with 16-1/2" "P" Style Brakes	Meritor 2210-X-5640 and 2210-Y-2443	8-9/16"	1-3/4"	Left Hand
CS41029	Meritor with 16-1/2" "P" Style Brakes	Meritor 2210-W-5639 and 2210-X-2442	8-9/16"	1-3/4"	Right Hand
CS41036	Meritor with 16-1/2" "P" Style Brakes	Meritor 2210-Z-5720 and 2210-D-3046	11-3/4"	1-3/4"	Left Hand
CS41037	Meritor with 16-1/2" "P" Style Brakes	Meritor 2210-Y-5719 and 2210-E-3047	11-3/4"	1-3/4"	Right Hand

Meritor with 16-1/2" "Q" & "Q" Plus Brakes

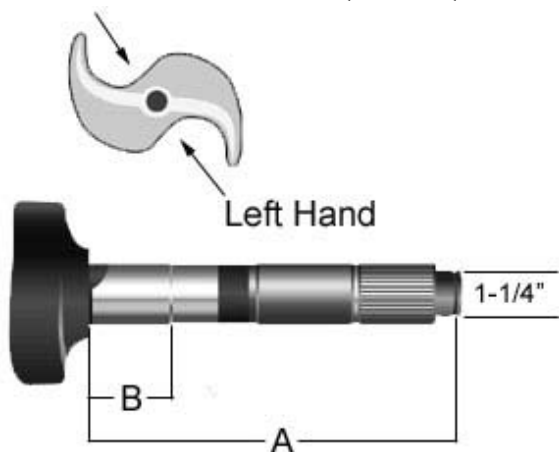

Typical – Left Hand Shown

Features:

- 1-1/2" Diameter – 28 Spline

Specifications:

Nominal Head Dimension – "Q" Standard	1-3/8"
Nominal Head Dimension – "Q" Plus	1-1/8"
Bushing Kit – Standard	CQ67387
Bushing Kit – Short Kit	CQ66940
Bushing Kit – Mack Application	CQ66939
Bushing Kit – 2-1/2" Offset Spider	CQ67413

Notes:

- 1) MUST REPLACE RIGHT & LEFT HAND S-CAMS WHEN "Q" PLUS CAMS ARE USED TO REPLACE EARLY DESIGN S-CAMS.
- 2) "Q" PLUS S-CAMS MAY BE USED IN "Q" APPLICATIONS; "Q" S-CAMS CAN NOT BE USED IN "Q" PLUS APPLICATIONS.

SKU#	Product Description	Replaces "Q" Standard	Replaces "Q" Plus	A	B	Notes
CS40172	Meritor with 16-1/2" "Q" & "Q" Plus Brakes	-	Meritor 2210-L-7396	7-23/32"	1-13/16"	Left Hand
CS40173	Meritor with 16-1/2" "Q" & "Q" Plus Brakes	-	Meritor 2210-K-7395	7-23/32"	1-13/16"	Right Hand
CS40174	Meritor with 16-1/2" "Q" & "Q" Plus Brakes	Meritor 2210-F-5440	Meritor 2210-Q-7427	8-9/16"	1-13/16"	Left Hand
CS40175	Meritor with 16-1/2" "Q" & "Q" Plus Brakes	Meritor 2210-E-5439	Meritor 2210-P-7426	8-9/16"	1-13/16"	Right Hand
CS40178	Meritor with 16-1/2" "Q" & "Q" Plus Brakes	Meritor 2210-F-5362	Meritor 2210-E-7493 and 2210-Q-6959	10-13/32"	1-13/16"	Left Hand
CS40179	Meritor with 16-1/2" "Q" & "Q" Plus Brakes	Meritor 2210-E-5361	Meritor 2210-D-7492 and 2210-P-6958	10-13/32"	1-13/16"	Right Hand
CS40182	Meritor with 16-1/2" "Q" & "Q" Plus Brakes	Meritor 2210-D-6036	Meritor 2210-J-7524 and 2210-A-7099	11-1/8"	1-13/16"	Left Hand
CS40183	Meritor with 16-1/2" "Q" & "Q" Plus Brakes	Meritor 2210-C-6035	Meritor 2210-H-7522 and 2210-Z-7098	11-1/8"	1-13/16"	Right Hand
CS40184	Meritor with 16-1/2" "Q" & "Q" Plus Brakes	Meritor 2210-B-5332 and 2210-L-5368	Meritor 2210-W-7537 and 2210-A-6943	11-9/16"	1-13/16"	Left Hand
CS40185	Meritor with 16-1/2" "Q" & "Q" Plus Brakes	Meritor 2210-A-5331 and 2210-K-5367	Meritor 2210-V-7536 and 2210-Z-6942	11-9/16"	1-13/16"	Right Hand
CS40186	Meritor with 16-1/2" "Q" & "Q" Plus Brakes	Meritor 2210-D-5334	Meritor 2210-C-7595 and 2210-A-6995	13-7/32"	1-13/16"	Left Hand
CS40187	Meritor with 16-1/2" "Q" & "Q" Plus Brakes	Meritor 2210-C-5333	Meritor 2210-B-7594 and 2210-Z-6994	13-7/32"	1-13/16"	Right Hand
CS40188	Meritor with 16-1/2" "Q" & "Q" Plus Brakes	Meritor 2210-N-5396	Meritor 2210-L-7604 and 2210-G-7001	13-7/16"	1-13/16"	Left Hand
CS40189	Meritor with 16-1/2" "Q" & "Q" Plus Brakes	Meritor 2210-M-5395	Meritor 2210-K-7603 and 2210-F-7000	13-7/16"	1-13/16"	Right Hand
CS40192	Meritor with 16-1/2" "Q" & "Q" Plus Brakes	Meritor 2210-N-5370	Meritor 2210-J-7628 and 2210-Q-6985	14-3/32"	1-13/16"	Left Hand
CS40193		Meritor 2210-M-5369		14-3/32"	1-13/16"	

# Drive Axle Camshafts

# 07-CAMSHAFTS/BUSHING KITS

	Meritor with 16-1/2" "Q" & "Q" Plus Brakes		Meritor 2210-H-7626 and 2210-P-6984			Right Hand
CS40196	Meritor with 16-1/2" "Q" & "Q" Plus Brakes	Meritor 2210-L-5446	Meritor 2210-A-7645	14-19/32"	1-13/16"	Left Hand
CS40197	Meritor with 16-1/2" "Q" & "Q" Plus Brakes	Meritor 2210-K-5445	Meritor 2210-Z-7644	14-19/32"	1-13/16"	Right Hand
CS40198	Meritor with 16-1/2" "Q" & "Q" Plus Brakes	Meritor 2210-L-5784	Meritor 2210-A-7671 and 2210-Y-7071	15-3/16"	1-13/16"	Left Hand
CS40199	Meritor with 16-1/2" "Q" & "Q" Plus Brakes	Meritor 2210-K-5783	Meritor 2210-Z-7670 and 2210-X-7070	15-3/16"	1-13/16"	Right Hand
CS41150	Meritor with 16-1/2" "Q" & "Q" Plus Brakes	Meritor 2210-T-5428	Meritor 2210-U-7457	9-7/16"	1-13/16"	Left Hand
CS41151	Meritor with 16-1/2" "Q" & "Q" Plus Brakes	Meritor 2210-S-5427	Meritor 2210-T-7456	9-7/16"	1-13/16"	Right Hand
CS41152	Meritor with 16-1/2" "Q" & "Q" Plus Brakes	Meritor 2210-H-5416	Meritor 2210-C-7543	11-11/16"	1-13/16"	Left Hand
CS41153	Meritor with 16-1/2" "Q" & "Q" Plus Brakes	Meritor 2210-G-5415	Meritor 2210-B-7542	11-11/16"	1-13/16"	Right Hand
CS41154	Meritor with 16-1/2" "Q" & "Q" Plus Brakes	Meritor 2210-X-5328	Meritor 2210-C-7569	12-7/16"	1-13/16"	Left Hand
CS41155	Meritor with 16-1/2" "Q" & "Q" Plus Brakes	Meritor 2210-W-5327	Meritor 2210-B-7568	12-7/16"	1-13/16"	Right Hand
CS41156	Meritor with 16-1/2" "Q" & "Q" Plus Brakes	Meritor 2210-L-5342	Meritor 2210-L-7587	12-15/16"	1-13/16"	Left Hand
CS41157	Meritor with 16-1/2" "Q" & "Q" Plus Brakes	Meritor 2210-K-5341	Meritor 2210-T-7586	12-15/16"	1-13/16"	Right Hand
CS41160	Meritor with 16-1/2" "Q" & "Q" Plus Brakes	Meritor 2210-Z-5434	Meritor 2210-A-7515	10-15/16"	1-13/16"	Left Hand
CS41161	Meritor with 16-1/2" "Q" & "Q" Plus Brakes	Meritor 2210-Y-5433	Meritor 2210-Z-7514	10-15/16"	1-13/16"	Right Hand
CS41172	Meritor with 16-1/2" "Q" & "Q" Plus Brakes	-	Meritor 2210-Y-7409	8-3/32"	1-13/16"	Left Hand
CS41173	Meritor with 16-1/2" "Q" & "Q" Plus Brakes	-	Meritor 2210-X-7408	8-3/32"	1-13/16"	Right Hand

Eaton with 15" Extended Service "ES" Brakes

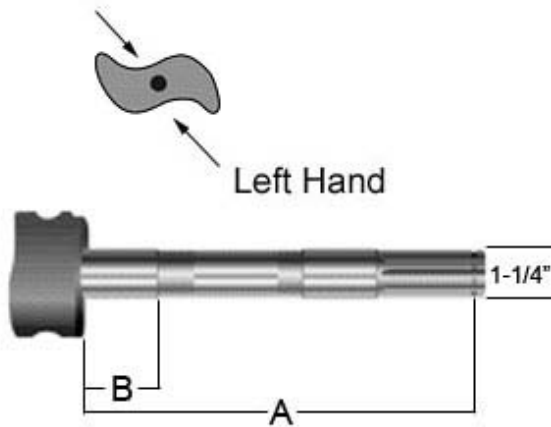

Typical – Left Hand Shown

Features:

- 1-1/4" Diameter – Spline 10

Specifications:

Nominal Head Dimension 1"  
 Bushing Kit CQ66918

Notes:

- 1) MUST REPLACE RIGHT & LEFT HAND S-CAMS WHEN EXTENDED SERVICE IS USED TO REPLACE EARLY DESIGN S-CAMS.

SKU#	Product Description	Replaces	A	B	Notes
CS41441	Eaton with 15" Extended Service "ES" Brakes	Eaton 813483	9-9/16"	1-7/8"	Right Hand
CS41442	Eaton with 15" Extended Service "ES" Brakes	Eaton 813494	9-25/32"	1-7/8"	Left Hand

Meritor with 15" "Q" Brakes – 1-1/2" Offset Spider

Features:

- 1-1/4" Diameter – 24 Spline

Specifications:

Nominal Head Dimension 1-3/16"  
 Bushing Kit CQ62768

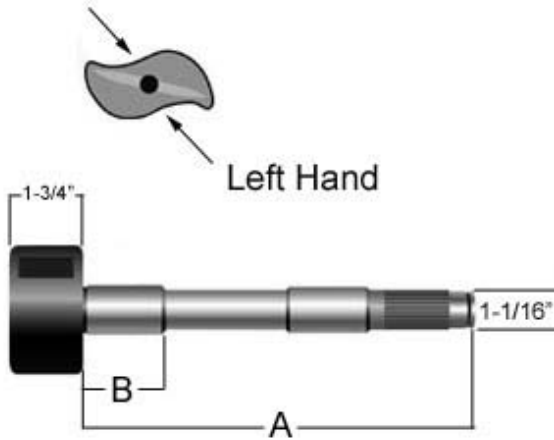

Typical – Left Hand Shown

SKU#	Product Description	Replaces	A	B	Notes
CS40116	Meritor with 15" "Q" Brakes – 1-1/2" Offset Spider	Meritor 2210-X-6731 and 2210-J-6614	8-1/2"	1-13/16"	Left Hand
CS40117	Meritor with 15" "Q" Brakes – 1-1/2" Offset Spider	Meritor 2210-X-6732 and 2210-K-6615	8-1/2"	1-13/16"	Right Hand

Meritor with 15" x 4" "Q" Plus Brakes

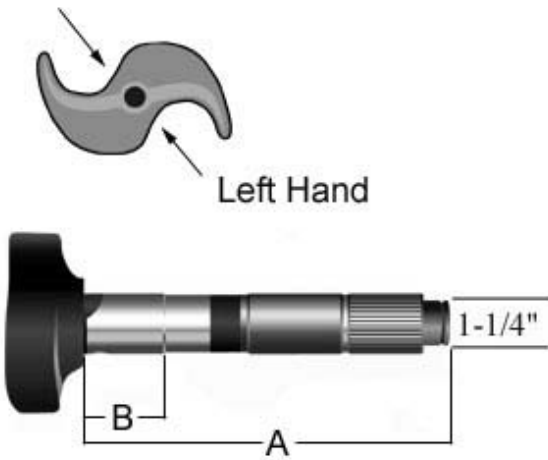

Typical – Left Hand Shown

Features:

- 1-1/2" Diameter – Spline 28

Specifications:

Nominal Head Dimension	1"
Bushing Kit – Complete	CQ67387
Bushing Kit – Minor	CQ66940

Notes:

- 1) MUST REPLACE RIGHT & LEFT HAND S-CAMS WHEN "Q" PLUS CAMS ARE USED TO REPLACE EARLY DESIGN S-CAMS.

SKU#	Product Description	Replaces	A	B	Notes
CS40134	Meritor with 15" x 4" "Q" Plus Brakes	Meritor 2210-S-7455	9-7/16"	2"	Left Hand
CS40135	Meritor with 15" x 4" "Q" Plus Brakes	Meritor 2210-R-7454	9-7/16"	2"	Right Hand

Dana Spicer with 12-1/4" Fast-Rise Brakes – Pre-1996

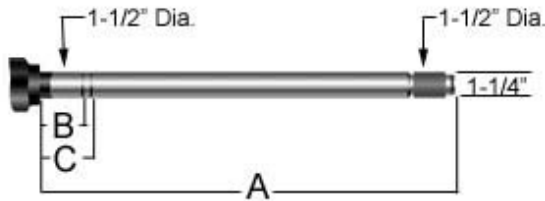
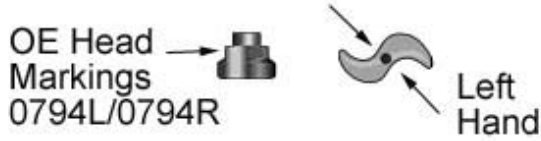

Typical – Left Hand Shown

Features:

- 1-1/2" Diameter – 28 Spline

Specifications:

Nominal Head Dimension	11/16"
Bushing Kit – w/Nylon Bushing	CQ67382
Bushing Kit – w/Bronze Bushing	CQ67383

Notes:

- 1) MUST USE WITH FABRICATED OPEN END BRAKE SHOES AND 1-1/2" DIAMETER ROLLERS.
- 2) WHEN CONVERTING FROM EARLY DESIGN FAST-RISE WITH 7/8" S-CAM HEAD, MUST REPLACE ALL CAMSHAFTS.
- 3) MUST USE WITH BRAKE HARDWARE KITS **CQ67405**, **CQ67506** or **CQ69006**.

SKU#	Product Description	Replaces	A	B	C	Notes
CS41362	Dana Spicer with 12-1/4" Fast-Rise Brakes – Pre-1996	Spicer M12WKL20-233	23-3/16"	2-7/32"	2-21/32"	Left Hand
CS41363	Dana Spicer with 12-1/4" Fast-Rise Brakes – Pre-1996	Spicer M12WKR20-233	23-3/16"	2-7/32"	2-21/32"	Right Hand

Dana Spicer with 16-1/2" Brakes – Double Groove

Features:

- 1-1/2" Diameter – 28 Spline

Specifications:

Nominal Head Dimension 1-3/8"  
 Bushing Kit CQ67332

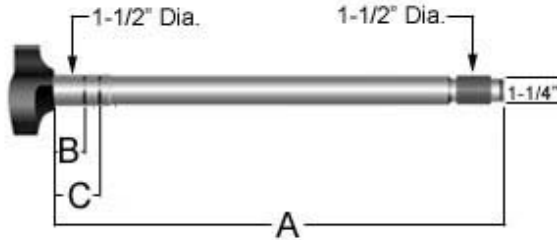

Typical – Left Hand Shown

SKU#	Product Description	Replaces	A	B	C	Notes
CS41052	Dana Spicer with 16-1/2" Brakes – Double Groove	Spicer M16WK104-17	20-3/8"	1-5/8"	2-7/32"	Right Hand
CS41053	Dana Spicer with 16-1/2" Brakes – Double Groove	Spicer M16WK105-17	20-3/8"	1-5/8"	2-7/32"	Left Hand
CS41164	Dana Spicer with 16-1/2" Brakes – Double Groove	Spicer M16WK104-25	23-7/16"	1-5/8"	2-7/32"	Left Hand
CS41165	Dana Spicer with 16-1/2" Brakes – Double Groove	Spicer M16WK105-25	23-7/16"	1-5/8"	2-7/32"	Right Hand



Dana Spicer with 16-1/2" Brakes – Single Groove

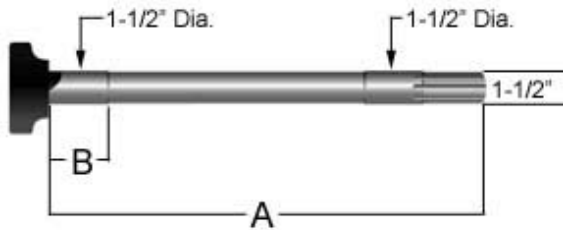
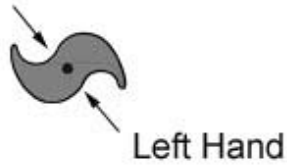

Typical – Left Hand Shown

Features:

- 1-1/2" Diameter – 10 Spline

Specifications:

Nominal Head Dimension 1-3/8"  
 Bushing Kit CQ67332

SKU#	Product Description	Replaces	A	B	Notes
CS41168	Dana Spicer with 16-1/2" Brakes – Single Groove	Spicer 17-593	26-1/2"	2-7/32"	Left Hand
CS41169	Dana Spicer with 16-1/2" Brakes – Single Groove	Spicer 17-592	26-1/2"	2-7/32"	Right Hand

Dana Spicer with 16-1/2" "Xtralife" Brakes – 1-5/8" Spider Bushing

Features:

- 1-1/2" Diameter –28 Spline

Specifications:

Nominal Head Dimension 1-1/8"  
 Bushing Kit CQ67111

Notes:

- 1) MUST REPLACE RIGHT & LEFT HAND S-CAMS WHEN "XTRALIFE" CAMS ARE USED TO REPLACE EARLY DESIGN S-CAMS.

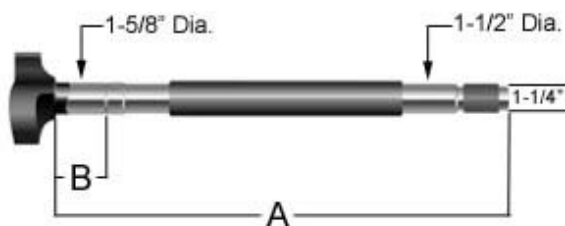
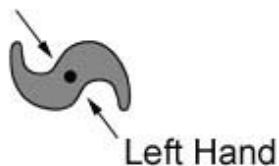

Typical – Left Hand Shown

SKU#	Product Description	Replaces	A	B	Notes
CS41414	Dana Spicer with 16-1/2" "Xtralife" Brakes – 1-5/8" Spider Bushing	Spicer M16WKL25-175	17-7/16"	2-7/32"	Left Hand
CS41415	Dana Spicer with 16-1/2" "Xtralife" Brakes – 1-5/8" Spider Bushing	Spicer M16WKR25-175	17-7/16"	2-7/32"	Right Hand
CS41416	Dana Spicer with 16-1/2" "Xtralife" Brakes – 1-5/8" Spider Bushing	Spicer M16WKL25-205	20-7/16"	2-7/32"	Left Hand
CS41417	Dana Spicer with 16-1/2" "Xtralife" Brakes – 1-5/8" Spider Bushing	Spicer M16WKR25-205	20-7/16"	2-7/32"	Right Hand
CS41420	Dana Spicer with 16-1/2" "Xtralife" Brakes – 1-5/8" Spider Bushing	Spicer M16WKL25-236	23-9/16"	2-7/32"	Left Hand
CS41421	Dana Spicer with 16-1/2" "Xtralife" Brakes – 1-5/8" Spider Bushing	Spicer M16WKR25-236	23-9/16"	2-7/32"	Right Hand
CS41422	Dana Spicer with 16-1/2" "Xtralife" Brakes – 1-5/8" Spider Bushing	Spicer M16WKL25-242	24-1/16"	2-7/32"	Left Hand
CS41423	Dana Spicer with 16-1/2" "Xtralife" Brakes – 1-5/8" Spider Bushing	Spicer M16WKR25-242	24-1/16"	2-7/32"	Right Hand
CS41432	Dana Spicer with 16-1/2" "Xtralife" Brakes – 1-5/8" Spider Bushing	Spicer M16WKL25-252	25-1/8"	2-7/32"	Left Hand
CS41433	Dana Spicer with 16-1/2" "Xtralife" Brakes – 1-5/8" Spider Bushing	Spicer M16WKR25-252	25-1/8"	2-7/32"	Right Hand
CS41434	Dana Spicer with 16-1/2" "Xtralife" Brakes – 1-5/8" Spider Bushing	Spicer M16WKL25-264	26-3/8"	2-7/32"	Left Hand
CS41435	Dana Spicer with 16-1/2" "Xtralife" Brakes – 1-5/8" Spider Bushing	Spicer M16WKR25-264	26-3/8"	2-7/32"	Right Hand

Dana Spicer with 16-1/2" "Xtralife" Brakes – 10 Spline

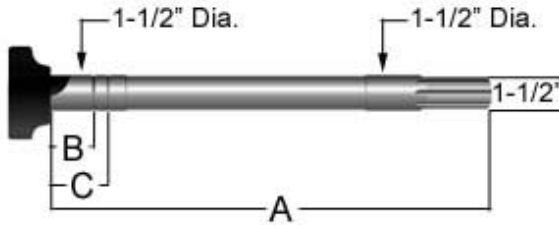
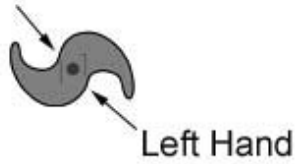

Typical – Left Hand Shown

Features:

- 1-1/2" Diameter – 10 Spline

Specifications:

Nominal Head Dimension 1-1/8"  
 Bushing Kit CQ67332

Notes:

- 1) MUST REPLACE RIGHT & LEFT HAND S-CAMS WHEN "XTRALIFE" CAMS ARE USED TO REPLACE EARLY DESIGN S-CAMS.

SKU#	Product Description	Replaces	A	B	C	Notes
CS41328	Dana Spicer with 16-1/2" "Xtralife" Brakes – 10 Spline	Spicer M16WKL10-205	20-3/8"	1-5/8"	2-7/32"	Left Hand
CS41329	Dana Spicer with 16-1/2" "Xtralife" Brakes – 10 Spline	Spicer M16WKR10-205	20-3/8"	1-5/8"	2-7/32"	Right Hand
CS41390	Dana Spicer with 16-1/2" "Xtralife" Brakes – 10 Spline	Spicer M16WKL10-236	23-1/2"	1-5/8"	2-7/32"	Left Hand
CS41391	Dana Spicer with 16-1/2" "Xtralife" Brakes – 10 Spline	Spicer M16WKR10-236	23-1/2"	1-5/8"	2-7/32"	Right Hand

Dana Spicer with 16-1/2" "Xtralife" Brakes – 28 Spline

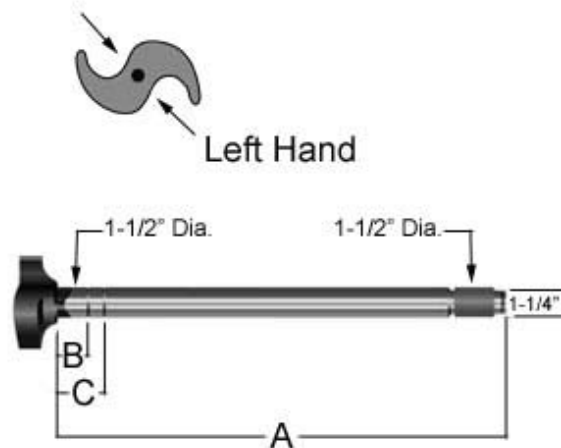

Typical – Left Hand Shown

Features:

- 1-1/2" Diameter – 10 Spline

Specifications:

Nominal Head Dimension 1-1/8"  
 Bushing Kit CQ67332

Notes:

- 1) MUST REPLACE RIGHT & LEFT HAND S-CAMS WHEN "XTRALIFE" CAMS ARE USED TO REPLACE EARLY DESIGN S-CAMS.

SKU#	Product Description	Replaces	A	B	C	Notes
CS41398	Dana Spicer with 16-1/2" "Xtralife" Brakes – 28 Spline	Spicer M16WKL20-175	17-7/16"	1-5/8"	2-7/32"	Left Hand
CS41399	Dana Spicer with 16-1/2" "Xtralife" Brakes – 28 Spline	Spicer M16WKR20-175	17-7/16"	1-5/8"	2-7/32"	Right Hand
CS41400	Dana Spicer with 16-1/2" "Xtralife" Brakes – 28 Spline	Spicer M16WKL20-205	20-7/16"	1-5/8"	2-7/32"	Left Hand
CS41401	Dana Spicer with 16-1/2" "Xtralife" Brakes – 28 Spline	Spicer M16WKR20-205	20-7/16"	1-5/8"	2-7/32"	Right Hand
CS41402	Dana Spicer with 16-1/2" "Xtralife" Brakes – 28 Spline	Spicer M16WKL20-231	22-15/16"	1-5/8"	2-7/32"	Left Hand
CS41403	Dana Spicer with 16-1/2" "Xtralife" Brakes – 28 Spline	Spicer M16WKR20-231	22-15/16"	1-5/8"	2-7/32"	Right Hand
CS41404	Dana Spicer with 16-1/2" "Xtralife" Brakes – 28 Spline	Spicer M16WKL20-236	23-9/16"	1-5/8"	2-7/32"	Left Hand
CS41405	Dana Spicer with 16-1/2" "Xtralife" Brakes – 28 Spline	Spicer M16WKR20-236	23-9/16"	1-5/8"	2-7/32"	Right Hand
CS41408	Dana Spicer with 16-1/2" "Xtralife" Brakes – 28 Spline	Spicer M16WKL20-242	24-1/16"	1-5/8"	2-7/32"	Left Hand
CS41409	Dana Spicer with 16-1/2" "Xtralife" Brakes – 28 Spline	Spicer M16WKR20-242	24-1/16"	1-5/8"	2-7/32"	Right Hand

## Dana Spicer – Standard Forge – Dexter with 12-1/4" Brakes

### Features:

- 1-1/2" Diameter – 10 Spline

### Specifications:

Nominal Head Dimension	1-1/16"
Bushing Kit – w/Nylon Bushing	CQ67382
Bushing Kit – w/Bronze Bushing	CQ67383

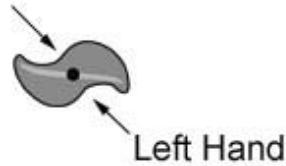

Typical – Left Hand Shown

SKU#	Product Description	Replaces	A	B	C	Notes
CS41718	Dana Spicer – Standard Forge – Dexter with 12-1/4" Brakes	Std. Forge 202103-233LH UB24-15L Spicer M12WK101-17	23-1/4"	2-7/32"	2-21/32"	Left Hand
CS41719	Dana Spicer – Standard Forge – Dexter with 12-1/4" Brakes	Std. Forge 202103-233RH UB24-15R Spicer M12WK100-17	23-1/4"	2-7/32"	2-21/32"	Right Hand
CS41722	Dana Spicer – Standard Forge – Dexter with 12-1/4" Brakes	Std. Forge 202103-241LH UB22-23L Spicer M12WK101-19	23-7/8"	2-7/32"	2-21/32"	Left Hand
CS41723	Dana Spicer – Standard Forge – Dexter with 12-1/4" Brakes	Std. Forge 202103-241RH UB22-23R Spicer M12WK100-19	23-7/8"	2-7/32"	2-21/32"	Right Hand
CS41762	Dana Spicer – Standard Forge – Dexter with 12-1/4" Brakes	Std. Forge 202103-213LH UB22-64L Spicer M12WK107-6	21-1/8"	2-7/32"	2-21/32"	Left Hand
CS41763	Dana Spicer – Standard Forge – Dexter with 12-1/4" Brakes	Std. Forge 202103-213RH UB22-64R Spicer M12WK106-6	21-1/8"	2-7/32"	2-21/32"	Right Hand

Dexter with 12-1/4" Brakes

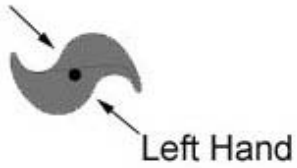

Features:

- 1-1/2" Diameter – 28 Spline

Specifications:

Nominal Head Dimension 15/16"  
 Bushing Kit CQ67382

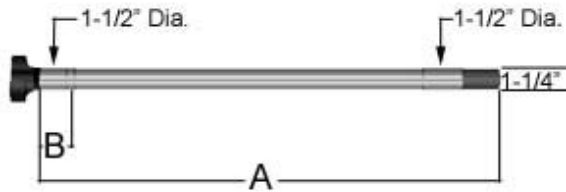

Typical – Left Hand Shown

SKU#	Product Description	Replaces	A	B	Notes
CS41226	Dexter with 12-1/4" Brakes	Dexter 034-188-05	23-3/8"	2-7/32"	Left Hand Special Length
CS41227	Dexter with 12-1/4" Brakes	Dexter 034-189-05	23-3/8"	2-7/32"	Right Hand Special Length

## Eaton with 12-1/4" Brakes

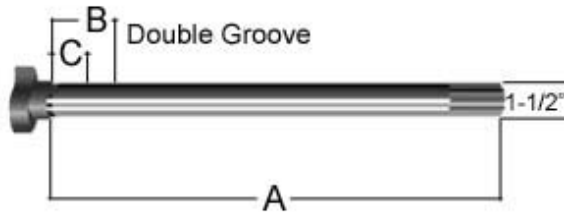
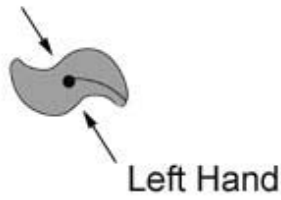

Typical - Left Hand Shown

### Features:

- 1-1/2" Diameter - 10 Spline; Double Groove

### Specifications:

Nominal Head Dimension	1-1/16"
Bushing Kit	CQ67410

SKU#	Product Description	Replaces	A	B	C	Notes
CS41714	Eaton with 12-1/4" Brakes	Eaton B-2460-55 B-2060-23 820243	22-5/16"	2-7/32"	1-11/32"	Left Hand
CS41715	Eaton with 12-1/4" Brakes	Eaton B-2460-56 B-2060-24 820244	22-5/16"	2-7/32"	1-11/32"	Right Hand

Eaton with 16-1/2" "ES" Extended Service Brakes – 10 Spline

Features:

- 1-1/2" Diameter – 10 Spline

Specifications:

Nominal Head Dimension 1-1/8"  
 Bushing Kit CQ67354

Notes:

- 1) MUST REPLACE RIGHT & LEFT HAND S-CAMS WHEN "ES" CAMS ARE USED TO REPLACE EARLY DESIGN S-CAMS.

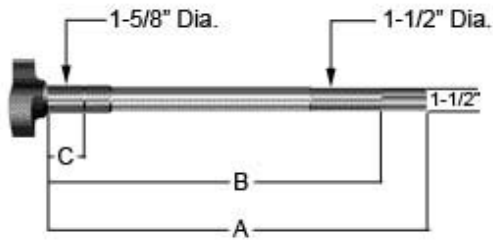
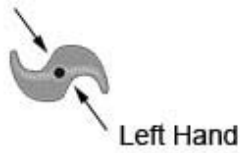

Typical – Left Hand Shown

SKU#	Product Description	Replaces	A	B	C	Notes
CS41476	Eaton with 16-1/2" "ES" Extended Service Brakes	Eaton 808078	19-1/2"	17-3/16"	2-5/32"	Left Hand
CS41477	Eaton with 16-1/2" "ES" Extended Service Brakes	Eaton 808079	19-1/2"	17-3/16"	2-5/32"	Right Hand



Eaton with 16-1/2" "ES" Extended Service Brakes – 28 Spline

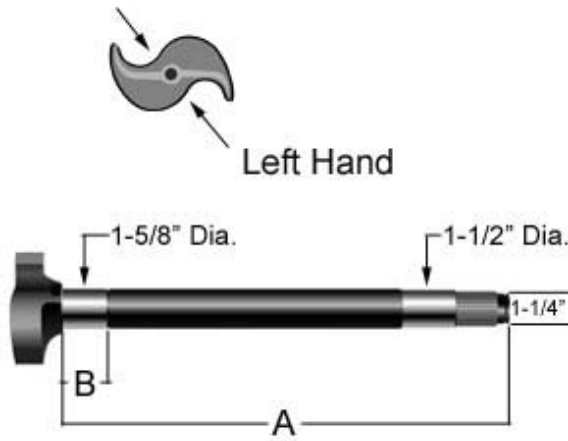

Typical – Left Hand Shown

Features:

- 1-1/2" Diameter – 28 Spline

Specifications:

Nominal Head Dimension 1-1/8"  
 Bushing Kit CQ67354

Notes:

- 1) MUST REPLACE RIGHT & LEFT HAND S-CAMS WHEN "ES" CAMS ARE USED TO REPLACE EARLY DESIGN S-CAMS.

SKU#	Product Description	Replaces	A	B	Notes
CS41480	Eaton with 16-1/2" "ES" Extended Service Brakes	Eaton 810538	19-1/2"	2-5/32"	Left Hand
CS41481	Eaton with 16-1/2" "ES" Extended Service Brakes	Eaton 810539	19-1/2"	2-5/32"	Right Hand
CS41482	Eaton with 16-1/2" "ES" Extended Service Brakes	Eaton 810025	23-3/4"	2-5/32"	Left Hand
CS41483	Eaton with 16-1/2" "ES" Extended Service Brakes	Eaton 810026	23-3/4"	2-5/32"	Right Hand

Eaton "501" Series with 16-1/2" Brakes

Features:

- 1-1/2" Diameter - 10 Spline

Specifications:

Nominal Head Dimension 1-3/8"  
 Bushing Kit CQ67354

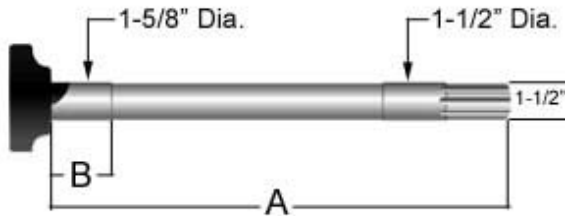
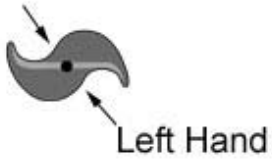

Typical - Left Hand Shown

SKU#	Product Description	Replaces	A	B	Notes
CS41292	Eaton "501" Series with 16-1/2" Brakes	Eaton 125034	19-1/2"	2-7/32"	Left Hand
CS41293	Eaton "501" Series with 16-1/2" Brakes	Eaton 125035	19-1/2"	2-7/32"	Right Hand
CS41544	Eaton "501" Series with 16-1/2" Brakes	Eaton 125030	23-3/4"	2-7/32"	Left Hand
CS41545	Eaton "501" Series with 16-1/2" Brakes	Eaton 125031	23-3/4"	2-7/32"	Right Hand

## Fruehauf "Propar" with 16-1/2" Brakes

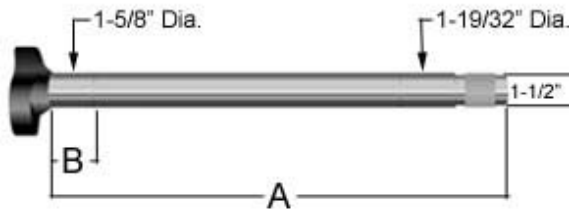
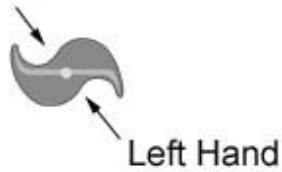

Typical – Left Hand Shown

### Features:

- 1-5/8" Diameter – 37 Spline

### Specifications:

Nominal Head Dimension 1-3/8"  
 Bushing Kit – Early Design CQ66740

SKU#	Product Description	Replaces	A	B	Notes
CS41492	Fruehauf "Propar" with 16-1/2" Brakes	Fruehauf AXA-0420-6	23-7/8"	2-5/32"	Left Hand
CS41493	Fruehauf "Propar" with 16-1/2" Brakes	Fruehauf AXA-0420-5	23-7/8"	2-5/32"	Right Hand
CS41512	Fruehauf "Propar" with 16-1/2" Brakes	Fruehauf AXA-0420-3	21-1/8"	2-5/32"	Left Hand
CS41513	Fruehauf "Propar" with 16-1/2" Brakes	Fruehauf AXA-0420-4	21-1/8"	2-5/32"	Right Hand
CS41528	Fruehauf "Propar" with 16-1/2" Brakes	Fruehauf AXA-0420-1	16-1/8"	2-5/32"	Left Hand
CS41529	Fruehauf "Propar" with 16-1/2" Brakes	Fruehauf AXA-0420-2	16-1/8"	2-5/32"	Right Hand

Hendrickson Intraax® 16-1/2" Brakes

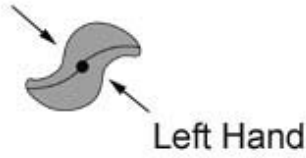

Features:

- 1-1/2" Diameter – 28 Spline

Specifications:

Nominal Head Dimension 1-1/8"  
 Bushing Kit CQ67414

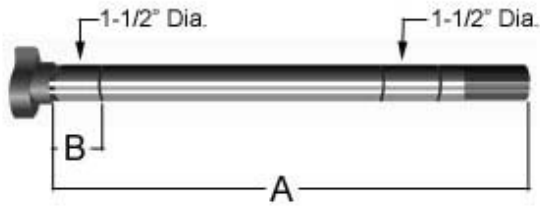

Typical – Left Hand Shown

SKU#	Product Description	Replaces	A	B	Notes
CS41174	Hendrickson Intraax® 16-1/2" Brakes	Hendrickson S-20806-1L and S-23347-1L	11-1/32"	2-5/16"	Left Hand – replaces standard and extra life camshafts.
CS41175	Hendrickson Intraax® 16-1/2" Brakes	Hendrickson S-20806-1R and S-23347-1R	11-1/32"	2-5/16"	Right Hand – replaces standard and extra life camshafts.

## Hendrickson "XLS" 16-1/2" Brakes

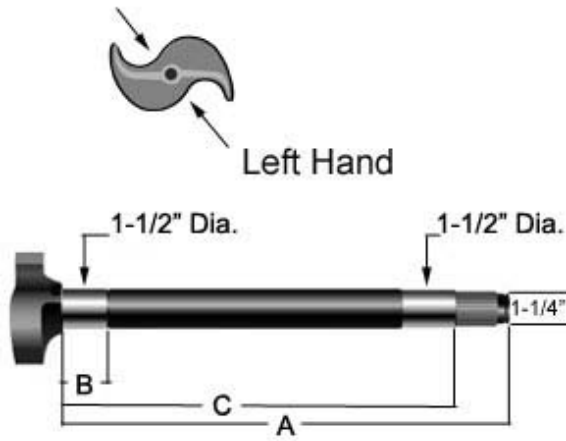

Typical - Left Hand Shown

**Features:**

- 1-1/2" Diameter - 28 Spline

**Specifications:**

Nominal Head Dimension 1-1/8"  
 Bushing Kit CQ67417, CQ67443

**Notes:**

- 1) "A" Dimension: under head to beginning of lock ring groove.

SKU#	Product Description	Replaces	A	B	C	Notes
CS41764	Hendrickson "XLS" 16-1/2" Brakes	Hendrickson S-24636-1L and Euclid E11866	11-1/32"	2-5/16"	8-11/16"	Left Hand
CS41765	Hendrickson "XLS" 16-1/2" Brakes	Hendrickson S-24636-1R and Euclid E11867	11-1/32"	2-5/16"	8-11/16"	Right Hand

Meritor with 16-1/2" "Q" Plus Brakes

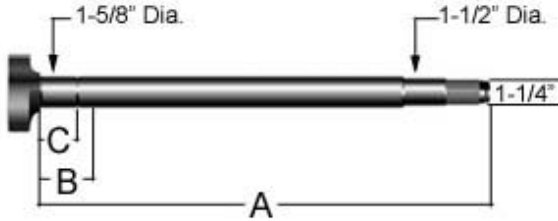

Typical – Left Hand Shown

Features:

- 1-1/2" Diameter – 28 Spline

Specifications:

Nominal Head Dimension	1-1/8"
Bushing Kit	CQ67386
Bushing Kit	CQ65517
Bushing Kit – w/Press-In Bushing	CQ67128
Bushing Kit – w/BoltOn Bushing	CQ67416

Notes:

- 1) MUST REPLACE RIGHT & LEFT HAND S-CAMS WHEN "Q" PLUS CAMS ARE USED TO REPLACE EARLY DESIGN S-CAMS.
- 2) CAN BE USED WITH CAST OR FABRICATED SPIDERS AND ALL SPIDER BUSHINGS.

SKU#	Product Description	Replaces	A	B	C	Notes
CS41110	Meritor with 16-1/2" "Q" Plus Brakes	Meritor 2210-R-8156	17-5/16"	2-5/64"	1-25/32"	Left Hand
CS41111	Meritor with 16-1/2" "Q" Plus Brakes	Meritor 2210-Q-8155	17-5/16"	2-5/64"	1-25/32"	Right Hand
CS41112	Meritor with 16-1/2" "Q" Plus Brakes	Meritor 2210-T-8158	20-13/32"	2-5/64"	1-25/32"	Left Hand
CS41113	Meritor with 16-1/2" "Q" Plus Brakes	Meritor 2210-S-8157	20-13/32"	2-5/64"	1-25/32"	Right Hand
CS41114	Meritor with 16-1/2" "Q" Plus Brakes	Meritor 2210-V-8160	24-1/16"	2-5/64"	1-25/32"	Left Hand
CS41115	Meritor with 16-1/2" "Q" Plus Brakes	Meritor 2210-U-8159	24-1/16"	2-5/64"	1-25/32"	Right Hand

Universal with 16-1/2" Brakes – Double Groove

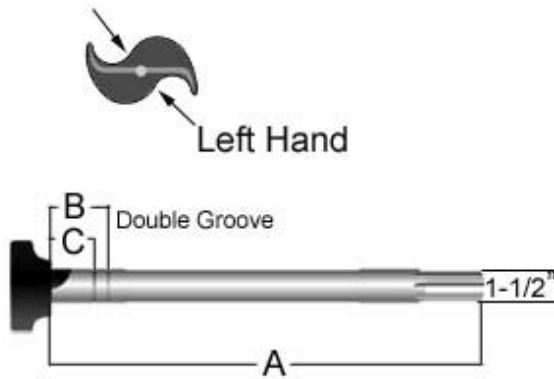

Features:

- 1-1/2" Diameter – 10 Spline; Double Groove

Specifications:

Nominal Head Dimension	1-3/8"
Bushing Kit – Eaton w/Bolt-On Spider	CQ67384
Bushing Kit – Eaton w/Weld-On Spider	CQ67325
Bushing Kit – Meritor Early Design	CQ67328
Bushing Kit – Std. Forge – Spicer Early	CQ67332

Typical – Left Hand Shown

SKU#	Product Description	Replaces	A	B	C	Notes
CS41506	Universal with 16-1/2" Brakes – Double Groove	Meritor 2210-N-2484, 2210-G-3595, 2210-F-5414 Fruehauf 219316 and 580443, Spicer M16WK103-17, Std. Forge 202100-205L, Trailmobile 7-5-64L	20-3/8"	2-7/32"	1-5/8"	Left Hand "Standard" Universal
CS41507	Universal with 16-1/2" Brakes – Double Groove	Meritor 2210-M-2483, 2210-F-3594, 2210-E-5413 Fruehauf 219317 and 580444, Spicer M16WK102-17, Std. Forge 202100-205R, Trailmobile 7-5-64R	20-3/8"	2-7/32"	1-5/8"	Right Hand "Standard" Universal
CS41522	Universal with 16-1/2" Brakes – Double Groove	Eaton F-1691-25 Std. Forge 202100-236L Spicer M16WK103-25	23-7/16"	2-7/32"	1-5/8"	Left Hand
CS41523	Universal with 16-1/2" Brakes – Double Groove	Eaton B1691-26 Std. Forge 202100-236R Spicer M16WKK102-25	23-7/16"	2-7/32"	1-5/8"	Right Hand

Universal with 16-1/2" Brakes – Single Groove

Features:

- 1-1/2" Diameter – 10 Spline; Single Groove

Specifications:

Nominal Head Dimension	1-3/8"
Bushing Kit – Eaton w/Bolt-On Spider	CQ67384
Bushing Kit – Eaton w/Weld-On Spider	CQ67325
Bushing Kit – Meritor Early Design	CQ67328
Bushing Kit – Std. Forge – Spicer Early	CQ67332

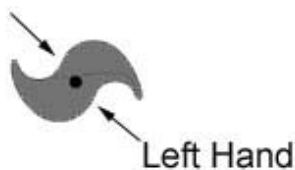

Typical – Left Hand Shown

SKU#	Product Description	Replaces	A	B	Notes
CS41266	Universal with 16-1/2" Brakes – Single Groove	Std. Forge 202100-175L Spicer M16WK117	17-3/8"	2-7/32"	Left Hand
CS41267	Universal with 16-1/2" Brakes – Single Groove	Std. Forge 202100-175R Spicer M16WK116	17-3/8"	2-7/32"	Right Hand
CS41284	Universal with 16-1/2" Brakes – Single Groove	Meritor 2210-N-1574 and 2210-E-1435 Std. Forge 202100-185L Eaton B-1691-5 Spicer M16WK103-12	18-3/8"	2-7/32"	Left Hand
CS41285	Universal with 16-1/2" Brakes – Single Groove	Meritor 2210-M-1573 Std. Forge 202100-185R Eaton B-1691-6 Spicer M16WK102-12	18-3/8"	2-7/32"	Right Hand
CS41514	Universal with 16-1/2" Brakes – Single Groove	Meritor 2210-U-2491 Eaton B-1691-17 Fruehauf 305680 Spicer M16WK103-19	21-3/32"	2-7/32"	Left Hand
CS41515	Universal with 16-1/2" Brakes – Single Groove	Meritor 2210-T-2490 Eaton B-1691-18 Fruehauf 305681 Spicer M16WK102-19	21-3/32"	2-7/32"	Right Hand
CS41524	Universal with 16-1/2" Brakes – Single Groove	Dana 16396 Meritor 2210-D-6400S Eaton 820084	24"	2-7/32"	Left Hand
CS41525	Universal with 16-1/2" Brakes – Single Groove	Dana 16395 Meritor 2210-C-6399S Eaton 820083	24"	2-7/32"	Right Hand
CS41542	Universal with 16-1/2" Brakes – Single Groove	Dana 16408 Meritor 2210-A-6345	22-7/8"	2-7/32"	Left Hand
CS41543	Universal with 16-1/2" Brakes – Single Groove	Dana 16407 Meritor 2210-Z-6344	22-7/8"	2-7/32"	Right Hand
CS41754	Universal with 16-1/2" Brakes – Single Groove	Std. Forge 202100-245L Spicer M16WK111-12	24-3/8"	2-7/32"	Left Hand
CS41755	Universal with 16-1/2" Brakes – Single Groove	Std. Forge 202100-245R Spicer M16WK110-12	24-3/8"	2-7/32"	Right Hand



CQ62768-66740



CQ62768



CQ65501



CQ65517



CQ66740

SKU#	Product Description	Replaces	Axle	Kit Includes	Notes
CQ62768	15" Meritor "Q" Series Brakes	(2) Meritor Kits 8022	Steer	(4) Bushings, (2) Lock Rings, (4) Seals, (4) Washers	Use with 1-1/4" diameter camshafts - single web.
CQ65501	15" Eaton Reduced Envelope / 16-1/2" Eaton "ES" & "ESII"	Eaton 127808	Steer / Drive	(8) Washers, (4) Bushings, (4) Seals, (2) Lock Rings	Reduced Envelope Air Brake / Extended Service
CQ65517	16-1/2" Meritor	Euclid E3989AHD	Trailer	(8) Washers, (6) Lock Rings, (4) Seals, (2) Inboard Bushing Assemblies, (2) Outboard Bushings	1-5/8" diameter camshaft with one piece spider bushings.
CQ66740	16-1/2" Fruehauf (Propar) Axles	-	Trailer	(4) Lock Rings, (8) Washers, (6) Bushings	With scalloped inboard bushings, early design.

CQ66918-66939



CQ66918



CQ66920



CQ66922



CQ66939

SKU#	Product Description	Replaces	Axle	Kit Includes	Notes
CQ66918	15" x 4" Eaton Single Anchor Pin Front Brakes	E-5140	Steer	(4) Bushings, (4) Seals, (4) Washers, (2) Lock Rings	Early design and "ES".
CQ66920	15" & 16-1/4" Meritor "T" Series Front Axle Brakes	E-3468	Steer	(4) Bushings, (10) Washers, (4) Seals, (2) Lock Rings	Use with 1-1/2" diameter camshafts, single web.
CQ66922	15" Meritor "T" Series Front Axle Brakes	E-3446	Steer	(4) Bushings, (4) Seals, (12) Washers, (2) Lock Rings	Midliner air brake, use with 1-1/4" diameter camshafts, single web.
CQ66939	16-1/2" Meritor "Q" & "Q" Plus (Mack)	-	Drive	(4) Bushings, (4) Seals, (4) Washers, (2) Gaskets, (2) Lock Rings	With 50,000 lb. rear axle, heavy duty application.

CQ66940-67111



SKU#	Product Description	Replaces	Axle	Kit Includes	Notes
CQ66940	15" & 16-1/2" Meritor "Q" & "Q" Plus	(2) Meritor Kits 8821	Steer / Drive	(4) Bushings, (4) Seals	Minor Kit - bushings and seals only, for 1-1/2" diameter camshafts, double web.
CQ66941	16-1/2" Meritor Trailers with Fabricated Spiders	Meritor Kit 8289	Trailer	(1) Bushing, (1) Lock Ring, (1) Washer, (2) Seals, (4) Attaching Screws	1-5/8" diameter camshaft, bolt-on spider bushings only.
CQ67100	16-1/2" x 7" Ford	Leland K302	Drive	(2) Lock Rings, (8) Washers, (4) Seals, (4) Bushings	Brazilian Cargo air brake.
CQ67111	16-1/2" Dana Spicer	Euclid E9790	Trailer	(4) Lock Rings, (10) Washers, (4) Seals, (4) Bushings	With 1-5/8" diameter camshafts, 1995 and newer.

CQ67128-67325



SKU#	Product Description	Replaces	Axle	Kit Includes	Notes
CQ67128	16-1/2" Meritor "Q" & "Q" Plus Brakes	Meritor Kit 8058	Trailer	(4) Bushings, (6) Lock Rings, (16) Washers, (4) Seals	1-5/8" diameter camshaft, with press-in metal bushings.
CQ67138	15" Ford Cargo	Leland K301	Steer	(4) Seals, (6) Washers, (2) Lock Rings, (4) Bushings	15" x 4" Brazilian Cargo.
CQ67324	12-1/4" & 16-1/2" Fruehauf	All late models	Trailer	(4) Lock Rings, (8) Washers, (6) Bushings	With spherical inboard bushings, current design.
CQ67325	16-1/2" Eaton/Schuler	22L & 23L 5" square axle, also late model "C" series round axle.	Trailer	(4) Lock Rings, (4) Bushings, (8) Washers, (4) Seals	With weld-on brake spiders.

CQ67326-67329

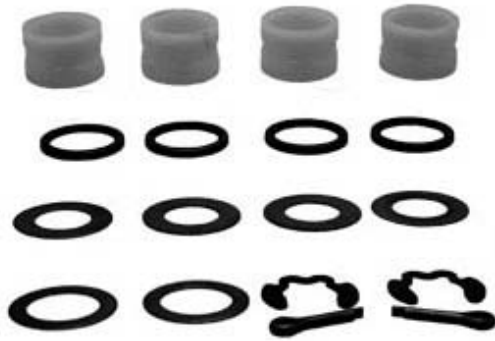

CQ67326



CQ67327



CQ67328



CQ67329

SKU#	Product Description	Replaces	Axle	Kit Includes	Notes
CQ67326	16-1/2" & 18" Eaton Self-Contained Tractor Brakes	E2125	Drive	(4) Bushings, (6) Washers, (4) Seals, (2) Lock Rings, (2) Cotter Pins	Early design single anchor pin.
CQ67327	16-1/2" Meritor Self-Contained "P" Series	E-2086	Steer / Drive	(4) Bushings, (4) Lock Rings, (6) Washers, (6) Seals	-
CQ67328	16-1/2" Meritor RN, RL & Late TK Axle	-	Trailer	(8) Washers, (6) Lock Rings, (4) Bushings	1-1/2" diameter camshaft, with two piece spider bushings.
CQ67329	16-1/2" Meritor TK, TKD, TKL, Fruehauf #5 Axle	-	Trailer	(6) Lock Rings, (6) Bushings, (8) Washers	1-1/2" diameter camshaft, with scalloped inboard bushings.

CQ67331-67335



SKU#	Product Description	Replaces	Axle	Kit Includes	Notes
CQ67331	16-1/2" Standard Forge & Early Dana Spicer	-	Trailer	(4) Lock Rings, (4) Bushings, (6) Washers, (4) Seals	With straight round inboard bushings.
CQ67332	16-1/2" & 18" Dana Spicer - Dexter - Standard Forge	Axles with weld-on spiders, also late model axles with 16-1/2" brakes	Trailer	(8) Lock Rings, (10) Washers, (4) Seals, (4) Bushings	With scalloped spherical inboard bushings.
CQ67334	16-1/2" Meritor RN Axle	-	Trailer	(8) Washers, (6) Lock Rings, (4) Bushings, (4) O-Ring Gaskets	1-5/8" diameter camshaft, loose outboard bushings.
CQ67335	15" Wagner	E-3353-A	Steer	(4) Bushings, (4) Washers, (4) Lock Rings, (4) Seals	-

CQ67353-67383



CQ67353



CQ67354



CQ67382



CQ67383

SKU#	Product Description	Replaces	Axle	Kit Includes	Notes
CQ67353	16-1/2" Dana Spicer	Dana Later Model Axle	Trailer	(4) Lock Rings, (6) Washers, (4) Bushings, (4) Seals, (4) O-Rings	With smooth spherical inboard bushings.
CQ67354	15" & 16-1/2" Eaton Late Model	501 Series Brakes	Trailer	(6) Lock Rings, (8) Washers, (4) Seals, (4) Bushings	15" Eaton Reduced Envelope.
CQ67382	12-1/4" Dana Spicer - Dexter	-	Trailer	(8) Washers, (4) Seals, (4) Lock Rings, (4) Bushings	-
CQ67383	12-1/4" Dana "U"	Late Model	Trailer	(4) Lock Rings, (6) Washers, (4) Bushings, (4) Seals	With weld-on brake spiders.

CQ67384-67387



CQ67384



CQ67385



CQ67386



CQ67387

SKU#	Product Description	Replaces	Axle	Kit Includes	Notes
CQ67384	16-1/2" Eaton/Schuler Early Model 5" Round Axle	E-2089	Trailer	(4) Lock Rings, (4) Bushings, (10) Washers, (4) Seals	With bolt-on brake spiders.
CQ67385	16-1/2" Meritor	Using One Piece Bushing	Trailer	(8) Washers, (6) Lock Rings, (2) Seals, (4) Bushings, (2) Gaskets	1-1/2" diameter camshaft, with green spider bushings.
CQ67386	12-1/4" Meritor "Q" & 16-1/2" Meritor RN, RL & Late TK Axle	E-3520-A	Trailer	(8) Washers, (6) Lock Rings, (2) Bushings, (2) Spider Bushings	1-5/8" diameter camshaft with two piece spider bushings.
CQ67387	15", 16-1/2" & 18" Meritor "Q" & "Q" Plus, Paccar	E-3993	Steer / Drive	(4) Bushings, (4) Seals, (4) Lock Rings, (10) Washers, (2) Gaskets	Use with 1-1/2" diameter camshafts - double web, Kenworth & Peterbilt Midranger.



## CQ67410-67413



SKU#	Product Description	Replaces	Axle	Kit Includes	Notes
CQ67410	12-1/4" Eaton	E-2494	Trailer	(4) Lock Rings, (4) Bushings, (8) Washers, (4) Seals	-
CQ67411	12-1/4" Dana Spicer	Early "S" Model Standard Forge	Trailer	(6) Washers, (6) Lock Rings, (4) Bushings, (8) Seals	With bolt-on brake spiders.
CQ67412	16-1/2" Eaton "ES" Severe Service / Late Model Trailer Axle	Late Model with 501 Series Brake	Drive / Trailer	(4) Bushings, (8) Washers, (4) Seals, (2) Lock Rings	-
CQ67413	16-1/2" Meritor "P", "Q" & "Q" Plus	-	Drive	(4) Bushings, (6) Washers, (6) Lock Rings, (4) Seals, (2) Gaskets	Use with 2-1/2" offset brake spiders.

CQ67414-67443



SKU#	Product Description	Replaces	Axle	Kit Includes	Notes
CQ67414	16-1/2" Hendrickson	Hendrickson S-21181	Trailer	(16) Washers, (2) Bushings, (4) Seals, (4) Lock Rings, (2) Support Assm	Intraax®, before 1998, 1-7/8" outside diameter outboard bushing.
CQ67416	16-1/2" Meritor "Q" & "Q" Plus	-	Trailer	(4) Bushings, (6) Lock Rings, (8) Washers, (4) Seals, (8) Screws	1-5/8" diameter camshaft with bolt-on spider bushings.
CQ67416W	16-1/2" Meritor "Q" & "Q" Plus Wheel Kit	-	Trailer	(2) Bushings, (3) Lock Rings, (4) Washers, (2) Seals, (4) Screws	1-5/8" diameter camshaft with bolt-on spider bushings.
CQ67417	16-1/2" Hendrickson "Q"	Hendrickson S-23974	Trailer	(2) Inboard Bushings, (4) Lock Rings, (4) Seals, (2) Outboard Bushings, (2) D Washers, (14) Washers	Intraax®, 1998 and newer, 2" outside diameter outboard bushing.
CQ67417W	16-1/2" Hendrickson "Q" Wheel Kit	Hendrickson S-23974	Trailer	(1) Inboard Bushings, (2) Lock Rings, (2) Seals, (1) Outboard Bushings, (1) D Washers, (7) Washers	Intraax®, 1998 and newer, 2" outside diameter outboard bushing.
CQ67443	16-1/2" Hendrickson "Intraax" Series	Hendrickson S-26348, Hendrickson S-28890, Euclid E11897, Leland K-503	Trailer	(2) Bushings, (2) Lock Rings, (1) Cam Tube, (1) Bracket, (5) Washers, (4) Screws, (4) Nuts	Intraax® Series Brake with Cam Tube

This page left blank intentionally.

Haldex develops and provides reliable and innovative solutions with focus on brake and air suspension products to the global commercial vehicle industry.

Listed on the Stockholm Stock Exchange, Haldex has annual sales of approximately 3.9 billion SEK and employs about 2,200 people.

Disclaimer: The products described within this literature, including without limitation, product features, specifications, designs, availability and pricing are subject to change by Haldex and its subsidiaries at any time without notice.

This document and other information from Haldex, its subsidiaries and authorized distributors provide product and/or system options for further investigation by users having technical expertise. It is important that you analyze all aspects of your application and review the information concerning the product or system, in the current literature or catalog. Due to the variety of operating conditions and applications for these products or systems, the user, through their own analysis and testing, is solely responsible for making the final selection of the products and systems and assuring that all performance, safety and warning requirements are met.

©2014, Haldex AB - This material may contain Haldex trademarks and third party trademarks, trade names, corporate logos, graphics and emblems which are the property of their respective companies. The contents of this document may not be copied, distributed, adapted or displayed for commercial purposes or otherwise without prior written consent from Haldex.

Innovative Vehicle Solutions

#### Austria

Haldex Wien Ges.m.b.H.  
Vienna  
Tel.: +43 1 8 69 27 97  
Fax: +43 1 8 69 27 97 27  
E-Mail: info.at@haldex.com

#### Belgium

Haldex N.V.  
Balegem  
Tel.: +32 9 363 90 00  
Fax: +32 9 363 90 09  
E-Mail: info.be@haldex.com

#### Brazil

Haldex do Brasil Ind. E Com. Ltda.  
São José dos Campos  
Tel.: +55 12 3935 4000  
Fax: +55 12 3935 4018  
E-Mail: info.brasil@haldex.com

#### Canada

Haldex Ltd.  
Cambridge, Ontario  
Tel.: +1 519 621 6722  
Fax: +1 519 621 3924  
E-Mail: info.ca@haldex.com

#### China

Haldex Vehicle Products Co. Ltd.  
Suzhou  
Tel.: +86 512 8885 5301  
Fax: +86 512 8765 6066  
E-Mail: info.cn@haldex.com

#### France

Haldex Europe SAS  
Weyersheim  
Tel.: +33 3 88 68 22 00  
Fax: +33 3 88 68 22 09  
E-Mail: info.eur@haldex.com

#### Germany

Haldex Brake Products GmbH  
Heidelberg  
Tel.: +49 6 221 7030  
Fax: +49 6 221 703400  
E-Mail: info.de@haldex.com

#### Hungary

Haldex Hungary Kft.  
Szentlőrincskáta  
Tel.: +36 29 631 400  
Fax: +36 29 631 401  
E-Mail: info.hu.eu@haldex.com

#### India

Haldex India Limited  
Nasik  
Tel.: +91 253 6699501  
Fax: +91 253 2380729

#### Italy

Haldex Italia Srl.  
Biassono  
Tel.: +39 039 47 17 02  
Fax: +39 039 27 54 309  
E-Mail: info.it@haldex.com

#### Korea

Haldex Korea Ltd.  
Seoul  
Tel.: +82 2 2636 7545  
Fax: +82 2 2636 7548  
E-Mail: info.hkr@haldex.com

#### Mexico

Haldex de Mexico S.A. De C.V.  
Monterrey  
Tel.: +52 81 8156 9500  
Fax: +52 81 8313 7090

#### Poland

Haldex Sp. z o.o.  
Praszka  
Tel.: +48 34 350 11 00  
Fax: +48 34 350 11 11  
E-Mail: info.pl@haldex.com

#### Russia

OOO "Haldex RUS"  
Moscow  
Tel.: +7 495 747 59 56  
Fax: +7 495 786 39 70  
E-Mail: info.ru@haldex.com

#### Spain

Haldex España S.A.  
Granollers  
Tel.: +34 93 84 07 239  
Fax: +34 93 84 91 218  
E-Mail: info.es@haldex.com

#### Sweden

Haldex Brake Products AB  
Landskrona  
Tel.: +46 418 47 60 00  
Fax: +46 418 47 60 01  
E-Mail: info.se@haldex.com

#### United Kingdom

Haldex Ltd.  
Newton Aycliffe  
Tel.: +44 1325 310 110  
Fax: +44 1325 311 834  
E-Mail: info.gb@haldex.com

Haldex Brake Products Ltd.  
MIRA Technology Park  
Tel.: +44 2476 400 300  
Fax: +44 2476 400 301  
E-Mail: info.gbre@haldex.com

#### USA

Haldex Brake Products Corp.  
Kansas City  
Tel.: +1 816 891 2470  
Fax: +1 816 891 9447  
E-Mail: info.us@haldex.com



www.haldex.com

L00122W US 6/14 WEB ONLY